

# Molecular biology (2)

(Foundation Block)

Dr. Ahmed Mujamammi

Dr. Sumbul Fatma

# Learning outcomes

- To understand DNA replication
- To know the transcription of genetic material into messenger RNA
- To get an idea about the translation of mRNA into a functional protein.

# DNA is the genetic material

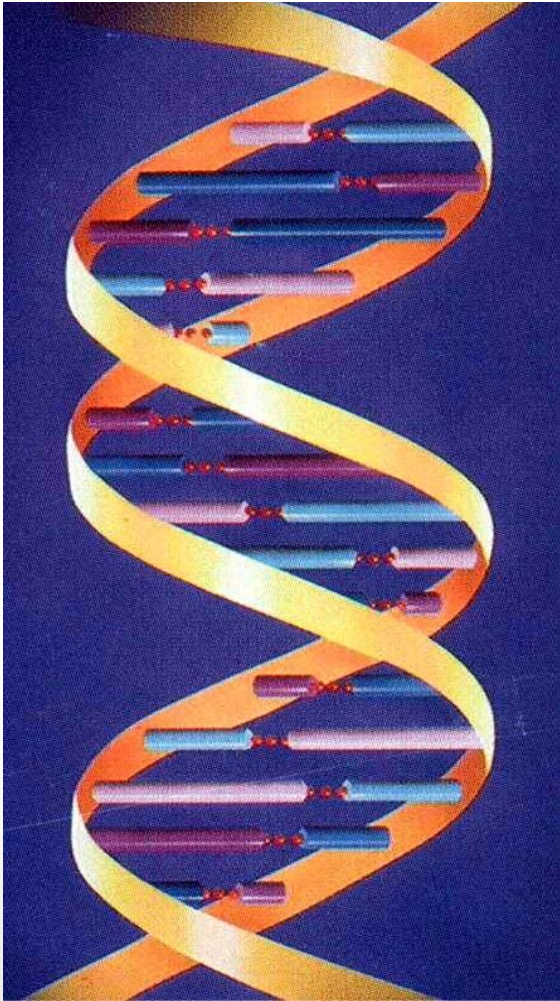

**Therefore it must:**

1. Replicate faithfully.
1. Have the coding ability to produce proteins for all cellular functions.

# Features of Eukaryotic DNA Replication

- ① Semiconservative with respect to parental strand:
  - Daughter DNA molecules contain one **parental strand** and one **newly-replicated strand**.

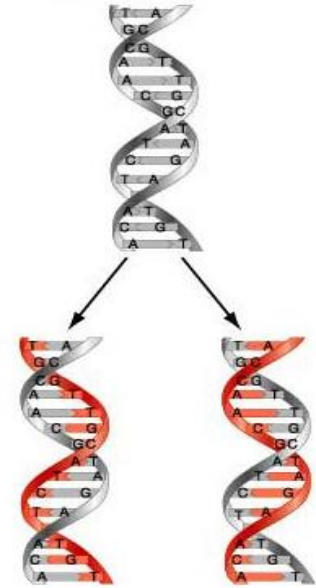

- ② Bidirectional with multiple origins of replication.

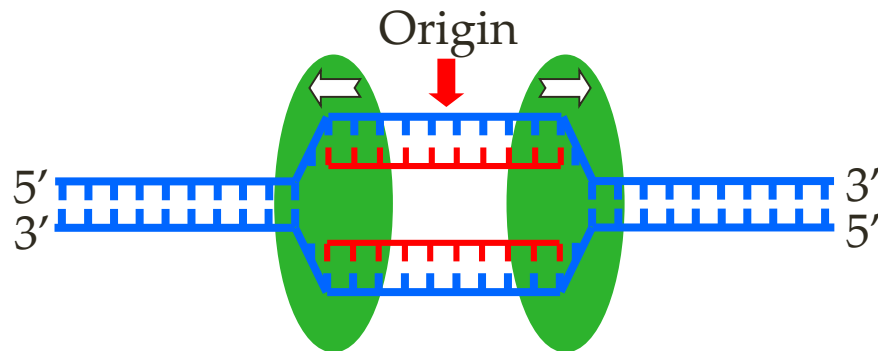

- ③ Primed by short stretches of RNA.
- ④ Semi-discontinuous

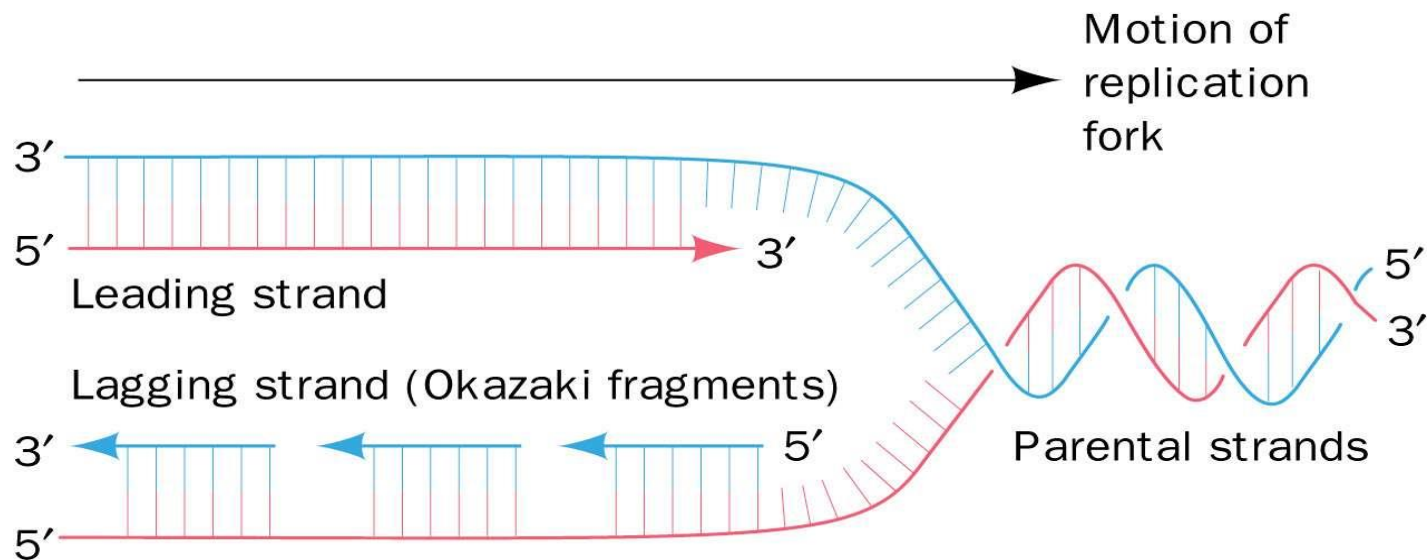

Semidiscontinuous DNA replication. In DNA replication, both daughter strands (*leading strand red*, *lagging strand blue*) are synthesized in their 5' → 3' directions

# Proteins involved in DNA Replication

- ① DNA Helicase.
- ② Single-stranded DNA binding proteins.
- ③ DNA Primase.
- ④ DNA polymerases (5 types:  $\alpha$ ;  $\beta$ ;  $\gamma$ ;  $\delta$ ;  $\epsilon$ ).
- ⑤ DNA ligase.
- ⑥ Topoisomerases:
  - ① Topoisomerase I.
  - ② Topoisomerase II.
- ⑦ Telomerases

# Steps in DNA Replication

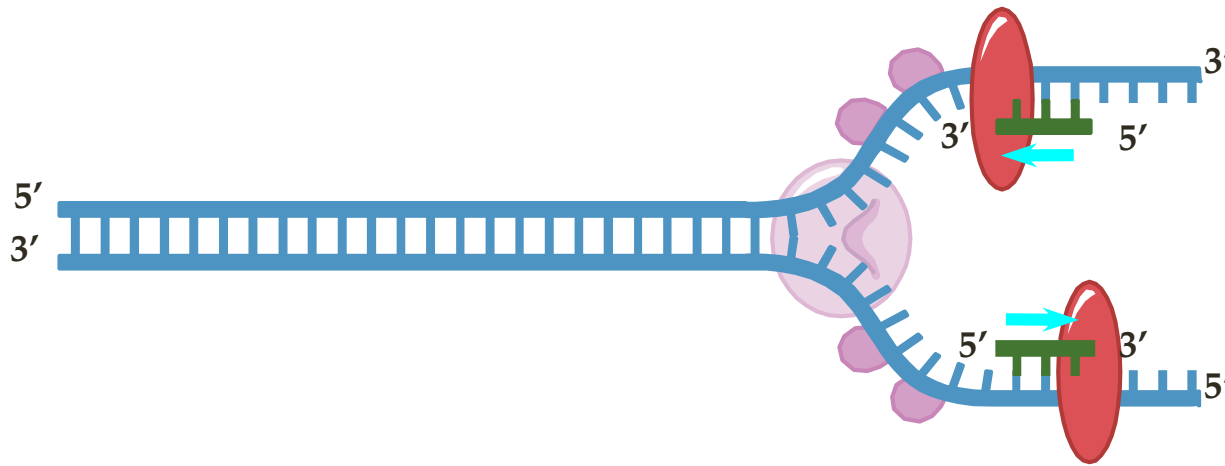

- **Helicase protein** binds to DNA sequences called origins and unwinds DNA strands.
- **Single-Stranded binding proteins** prevent single strands from rewinding.
- **Primase protein** makes a short segment of **RNA primer** complementary to the DNA.

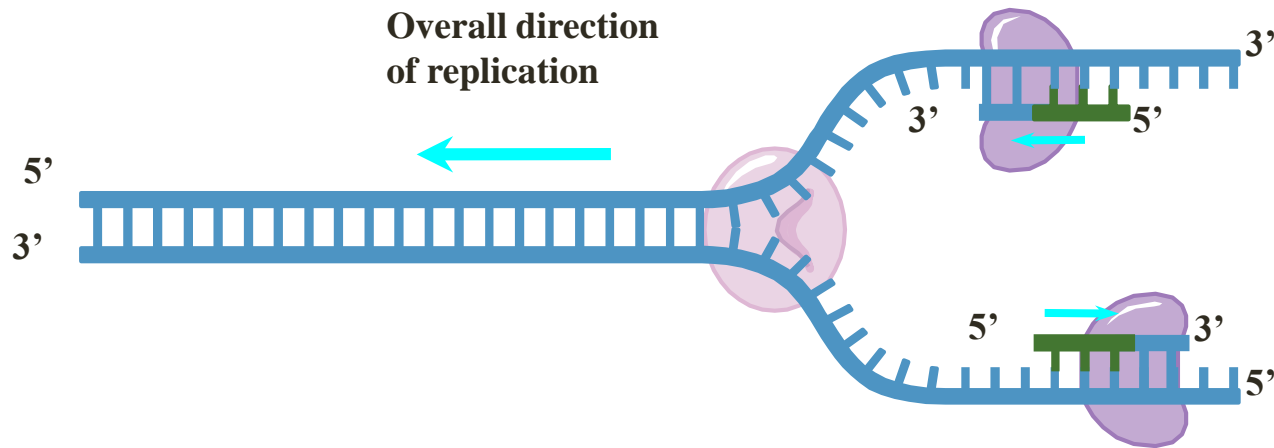

## DNA polymerase:

- Adds DNA nucleotides to the RNA primer.
- Proofreads bases added and replaces incorrect nucleotides



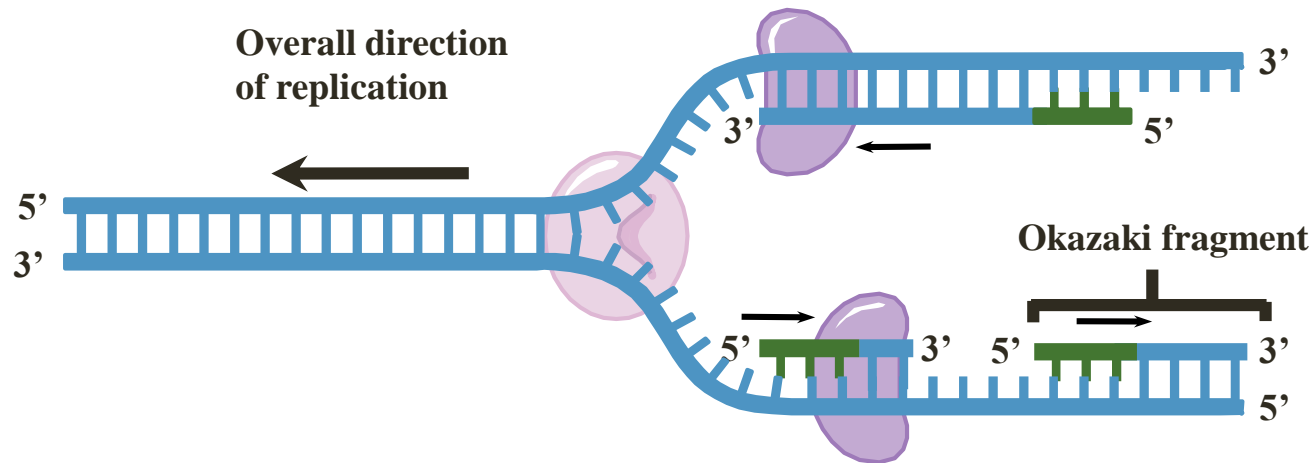

- Leading strand synthesis continues in a 5' to 3' direction.
- Discontinuous synthesis produces 5' to 3' DNA segments (Okazaki fragments).

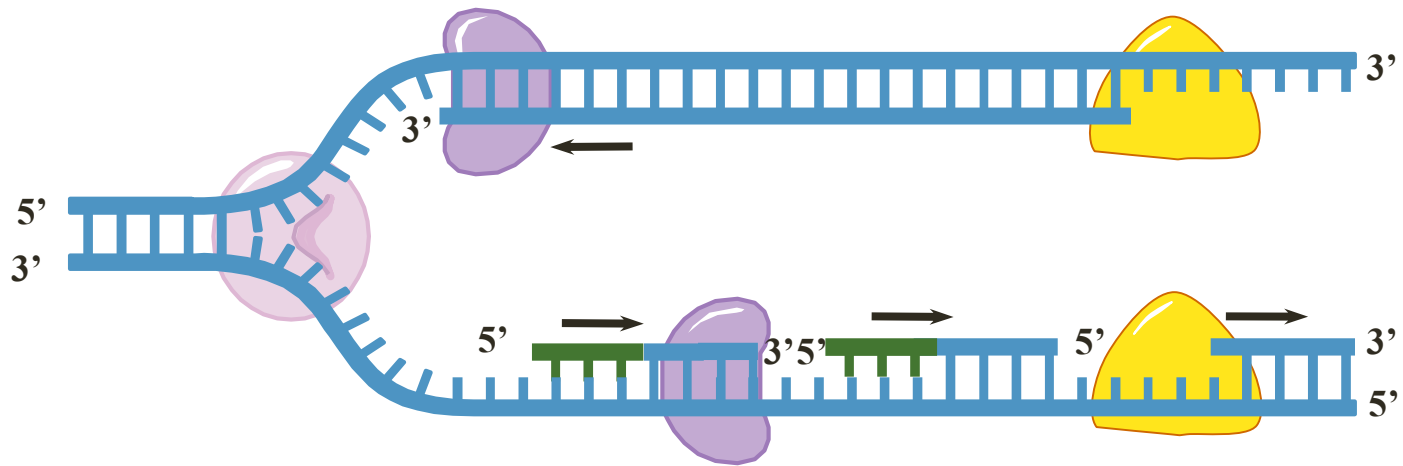

Exonuclease activity of **DNA polymerase** removes RNA primers

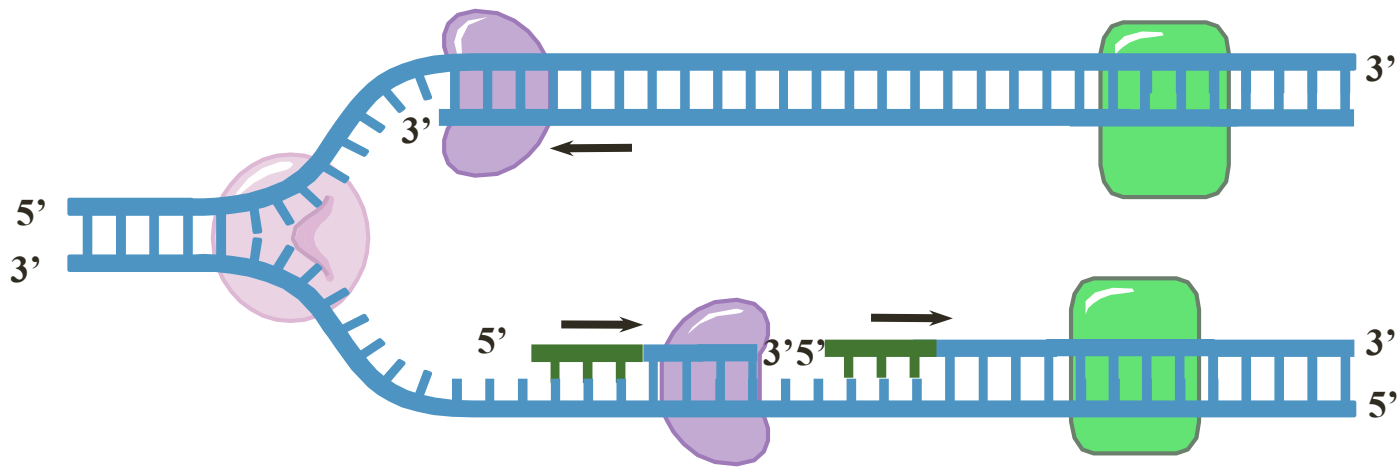

- DNA polymerase fills the gaps.
- **Ligase** forms bonds between sugar-phosphate backbone

# The central dogma of Molecular Biology

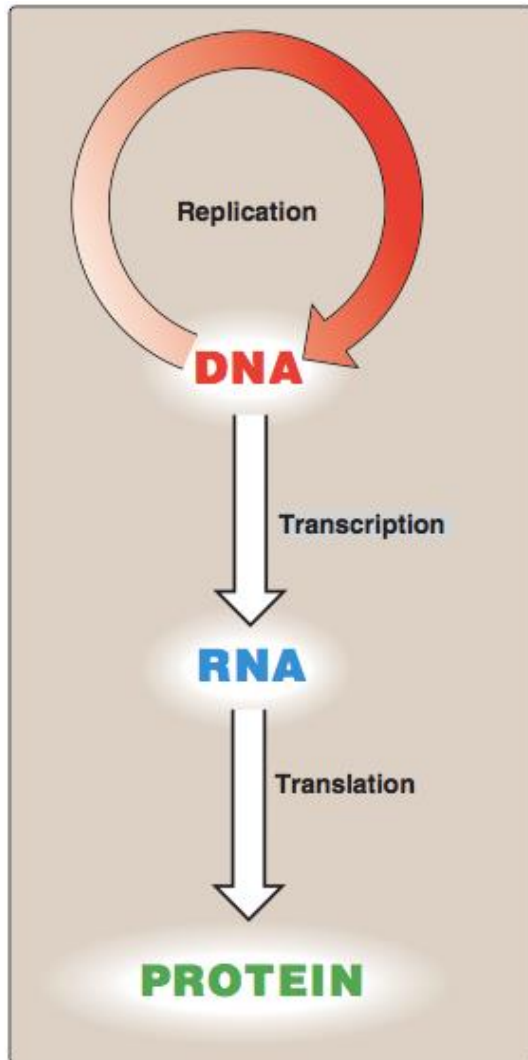

*A portion of DNA, called a gene, is transcribed into RNA.*

*RNA is translated into proteins.*

# Transcription (mRNA synthesis)

- A portion of **DNA** (a **gene**) is transcribed into messenger RNA (**mRNA**).
- Only one of the DNA strands is transcribed (**antisense strand**).
- The **RNA polymerase II** is responsible for this process.
- The direction of transcription is **5' → 3'**.

# Steps of mRNA synthesis

- **Chain initiation:**

- RNA polymerase II binds to *promoter region* of DNA to start transcription.

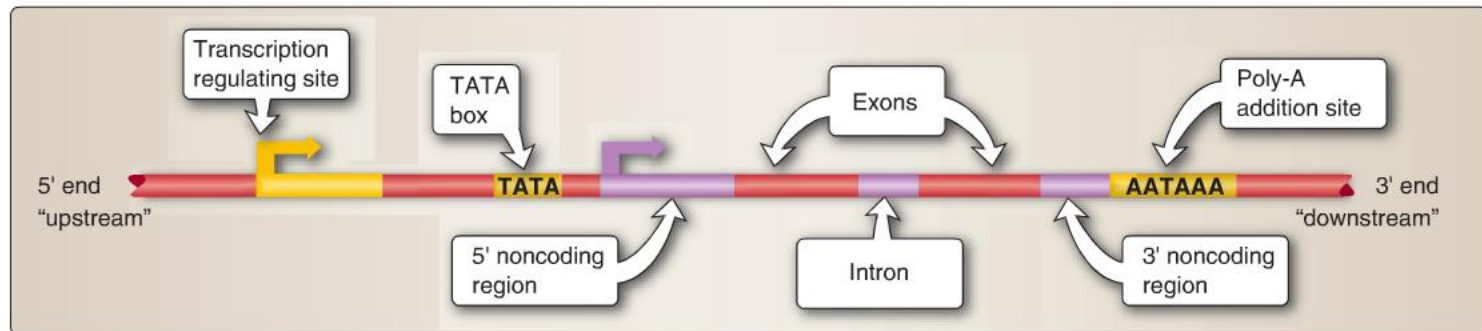

# Steps of mRNA synthesis

- **Chain elongation:**

- A portion of DNA template unwinds (opens) at the point of RNA synthesis.
- This forms a short length of RNA-DNA hybrid.

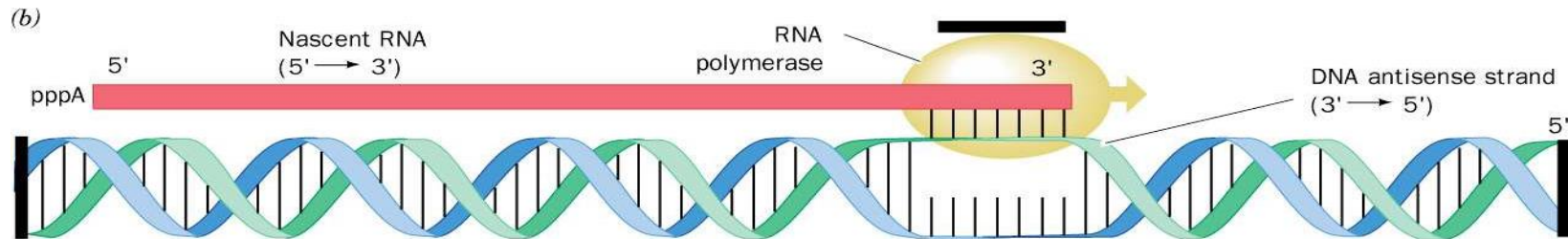

- **Chain termination:**

- DNA contains specific sites which stop transcription (at a sequence of 4-10 AT base pairs).

# Post-transcriptional modification

- **Capping:** Addition of a methylated guanine nucleotide at 5' end of mRNA

Function:

- *To prevent mRNA degradation by exonucleases.*
- *It helps the transcript bind to the ribosome during protein synthesis.*

- **Polyadenylation:** Addition of a poly(A) tail (a highly conserved AAUAA sequence) at 3' end of mRNA.

Functions:

- *To protect the mRNA from degradation*
  - *For ribosomal RNA recognition*
- **Intron removal for releasing mature mRNA from nucleus.**



# The central dogma of Molecular Biology

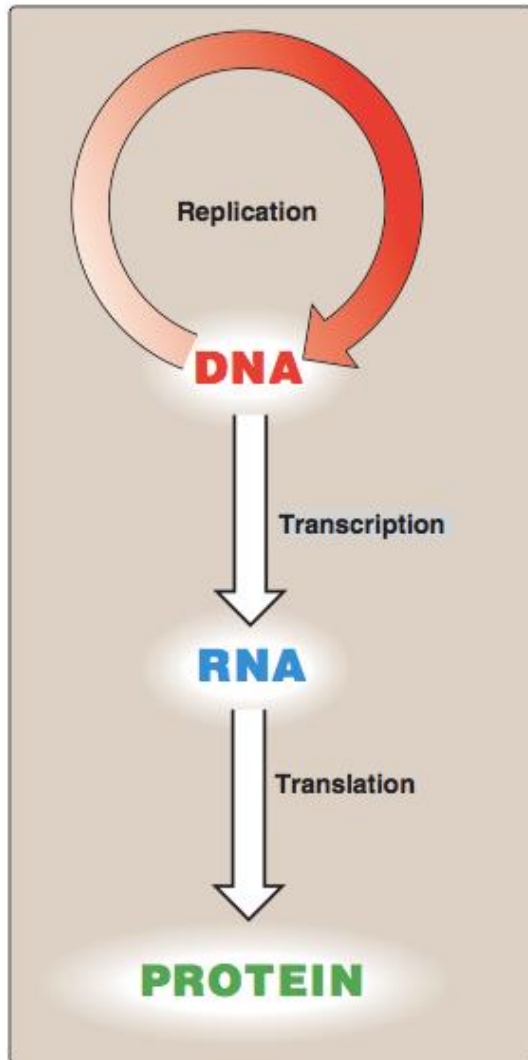

*A portion of DNA, called a gene, is transcribed into RNA.*

*RNA is translated into proteins.*

# Translation (Protein synthesis)

- A process of protein synthesis from mRNA
- mRNA has genetic codes for amino acids present in proteins.
- The **genetic code** is a dictionary that identifies the correspondence between a sequence of nucleotide bases and a sequence of amino acids.
- Each individual word in the code is composed of three nucleotide bases (**codons**).

• **64 possible codons:**

- 61 codons specify 20 amino acids
- One start codon (AUG)
- 3 stop codons  
 UAA, UAG and UGA

First position (5' end)	Second position				Third position (3' end)
	U	C	A	G	
<b>U</b>	UUU Phe	UCU	UAU Tyr	UGU Cys	<b>U</b> <b>C</b> <b>A</b> <b>G</b>
	UUC	UCC Ser	UAC	UGC	
	UUA Leu	UCA	UAA Stop	UGA Stop	
	UUG	UCG	UAG Stop	UGG Trp	
<b>C</b>	CUU	CCU	CAU His	CGU	<b>U</b> <b>C</b> <b>A</b> <b>G</b>
	CUC Leu	CCC Pro	CAC	CGC Arg	
	CUA	CCA	CAA Gln	CGA	
	CUG	CCG	CAG	CGG	
<b>A</b>	AUU	ACU	AAU Asn	AGU Ser	<b>U</b> <b>C</b> <b>A</b> <b>G</b>
	AUC Ile	ACC Thr	AAC	AGC	
	AUA	ACA	AAA Lys	AGA Arg	
	AUG Met <sup>b</sup>	ACG	AAG	AGG	
<b>G</b>	GUU	GCU	GAU Asp	GGU	<b>U</b> <b>C</b> <b>A</b> <b>G</b>
	GUC Val	GCC Ala	GAC	GGC Gly	
	GUA	GCA	GAA Glu	GGA	
	GUG	GCG	GAG	GGG	

# Components required for Translation

- ① Amino acids.
- ② Transfer RNA (tRNA).
- ③ Aminoacyl-tRNA synthetases.
- ④ mRNA.
- ⑤ Functionally competent ribosomes.
- ⑥ Protein factors.
- ⑦ ATP and GTP.

# Steps in Protein Translation

## INITIATION

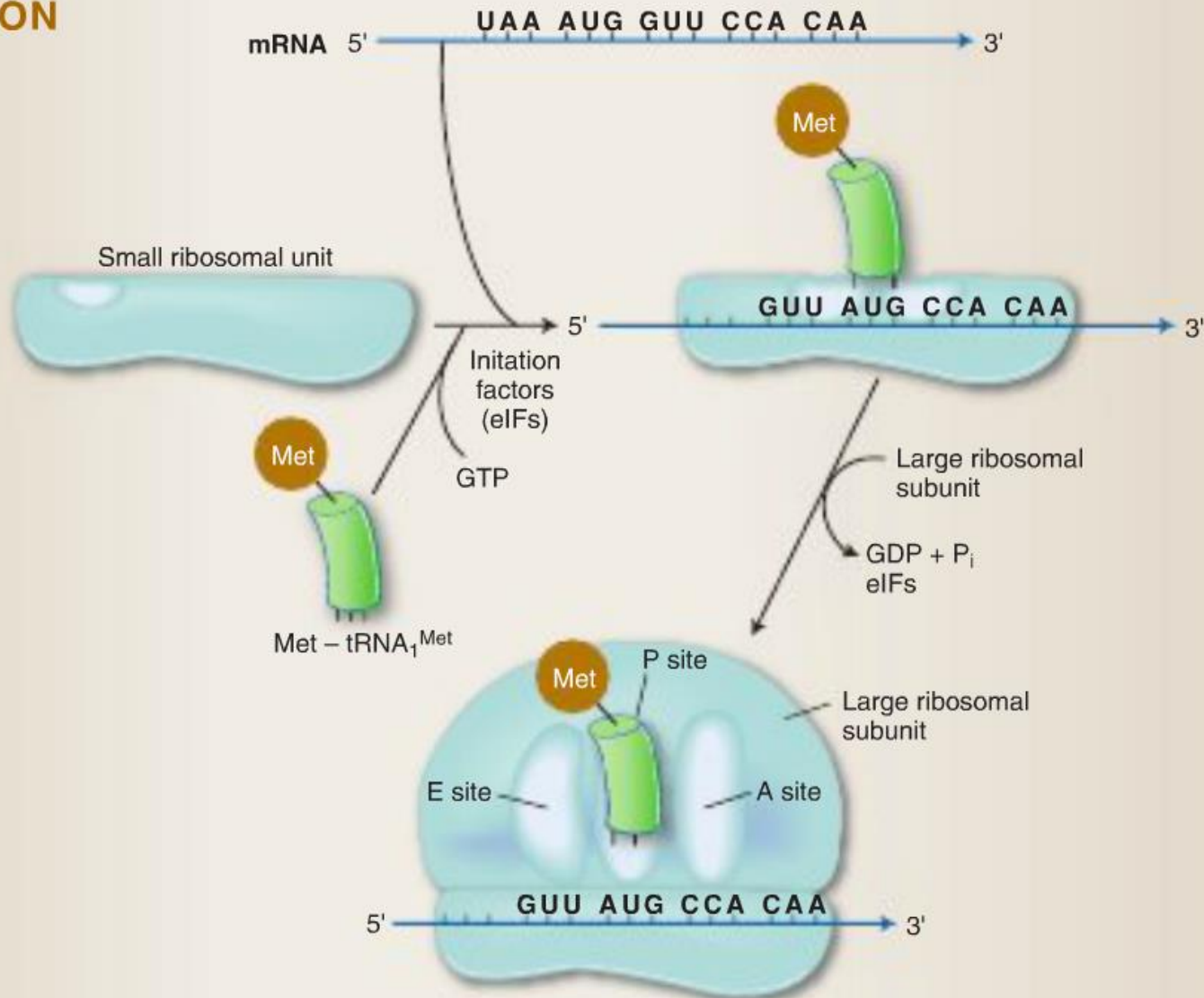

# ELONGATION

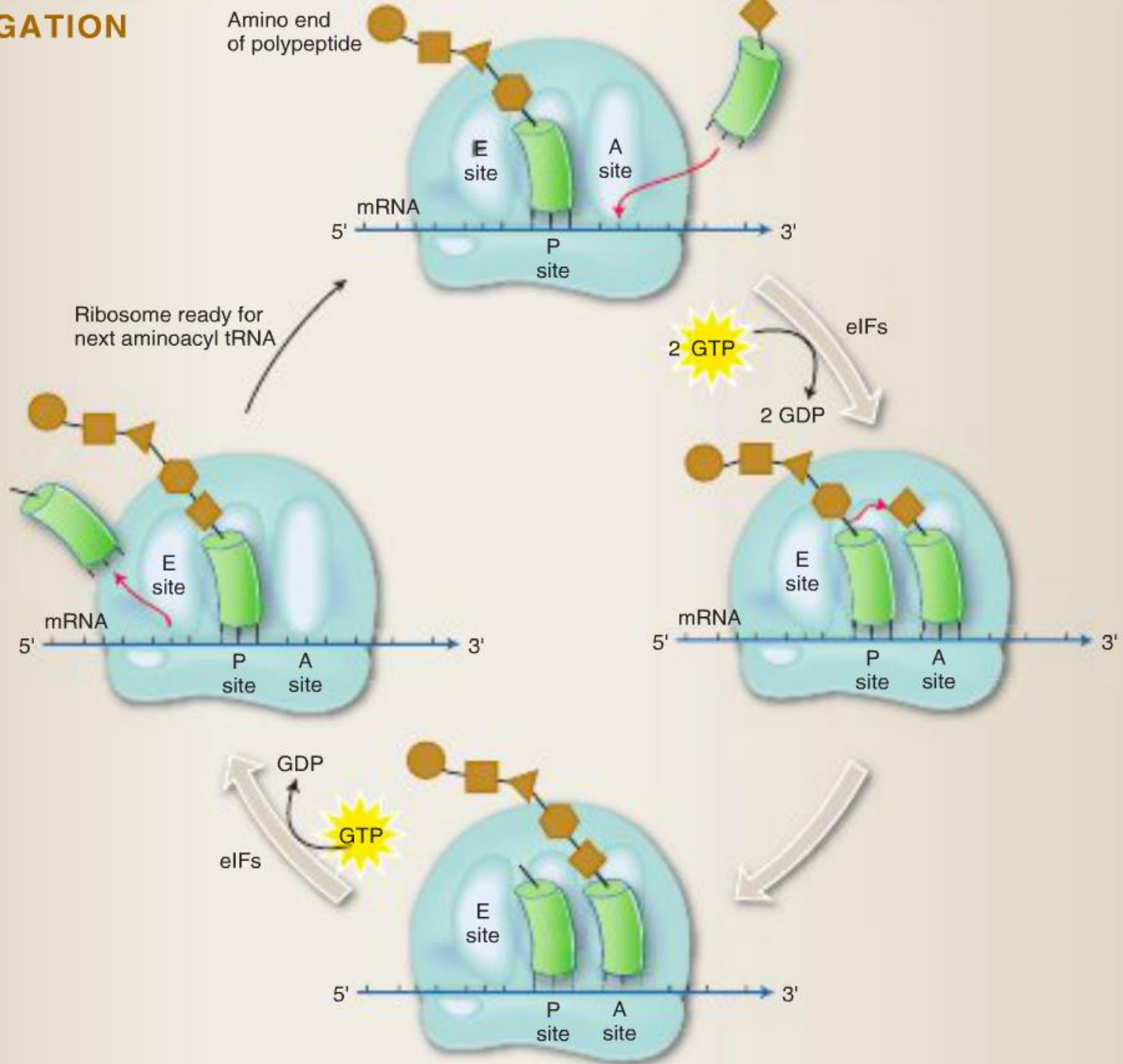

# TERMINATION

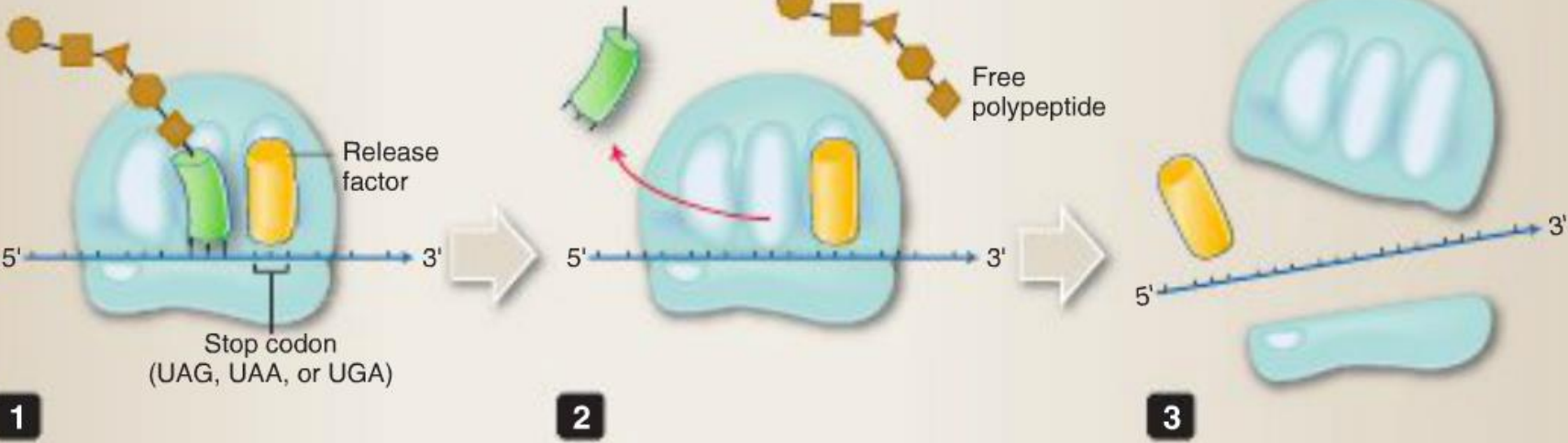

# References

Lippincott's Illustrated reviews: Biochemistry 4<sup>th</sup> edition – unit 6; chapters 29-31.

Lippincott's Illustrated reviews: Cell and Molecular Biology – unit 2; chapters 7-9.